

# ONKYO® SERVICE MANUAL

## COMPACT DISC AUTOMATIC CHANGER MODEL DX-C510

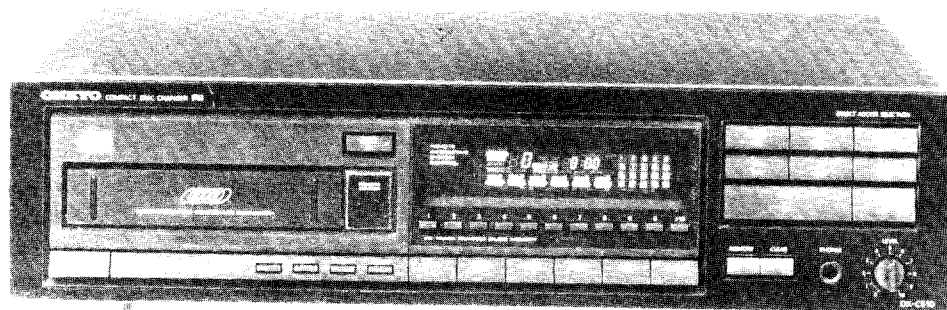

UD, UDN	120V AC, 60Hz
UU	110/120/220/240V AC, 50/60Hz

### SAFETY-RELATED COMPONENT WARNING!!

COMPONENTS IDENTIFIED BY MARK  $\triangle$  ON THE SCHEMATIC DIAGRAM AND IN THE PARTS LIST ARE CRITICAL FOR RISK OF FIRE AND ELECTRIC SHOCK. REPLACE THESE COMPONENTS WITH ONKYO PARTS WHOSE PART NUMBERS APPEAR AS SHOWN IN THIS MANUAL.

MAKE LEAKAGE-CURRENT OR RESISTANCE MEASUREMENTS TO DETERMINE THAT EXPOSED PARTS ARE ACCEPTABLY INSULATED FROM THE SUPPLY CIRCUIT BEFORE RETURNING THE APPLIANCE TO THE CUSTOMER.

### SPECIFICATIONS

Signal readout system:	Optical non-contact
Reading rotation:	About 500~200 r.p.m. (constant linear velocity)
Linear velocity:	1.2~1.4m/s
Error correction system:	Cross interleave readsolomon code
Decoded bits:	18 bits linear
Sampling frequency:	352.8kHz (eight-times oversampling)
Number of channels:	2 (stereo)
Frequency response:	5Hz~20kHz
Total harmonic distortion:	0.004% (at 1kHz)
Dynamic range:	98dB
Signal to noise ratio:	105dB
Channel separation:	100dB (at 1kHz)
Wow and Flutter:	Below threshold of measurability
Power consumption:	13 watts
Output level:	2 volts r.m.s.
Dimensions (W×H×D):	435×119×369mm 17-1/8"×4-11/16"×14-9/16"
Weight:	6.5kg, 14.3 lbs.

Specifications are subject to change without notice.

**ONKYO**  
**AUDIO COMPONENTS**

## TABLE OF CONTENTS

Specifications .....	1
Service procedures .....	2
Microprocessor descriptions .....	4
IC block diagram and descriptions .....	6
Adjustment procedures .....	12
Pc board view from bottom side	
Main circuit .....	15
Headphone amplifier .....	16
Remocon sensor .....	16
Power supply circuit .....	16
Display circuit .....	21
Schematic diagram .....	17
Pc board-parts list .....	21
Mechanism-parts list .....	24
Mechanism-exploded view .....	25
Exploded view .....	27
Parts list .....	28
Waveform of each section .....	29
Block diagram .....	31
Caution on replacement of pickup .....	33
Protection of eyes from laser beam	
during servicing .....	33
Laser warning lable .....	34
Packing view .....	35

## SERVICE PROCEDURES

### 1. Safety-check out

After correcting the original service problem, perform the following safety check before releasing the set to the customer:

Connect the insulating-resistance tester between the plug of power supply cable and chassis.

Specifications: more than 10Mohm at 500V.

### 2. Voltage selector (rear panel)

Worldwide models are equipped with a voltage selector to conform with local power supplies. Be sure to set this selector to match the voltage of the power supply in your area before turning the power switch on. Voltage is changed by turning the voltage selector with a screwdriver or similar instrument to the 110V, 120V, 220V or 240V position. Confirm that the selector has been set to the correct position before turning the power switch on. If there is no voltage selector switch on the unit you have purchased, it can only be used in areas where the power supply voltage is the same as that of the unit.

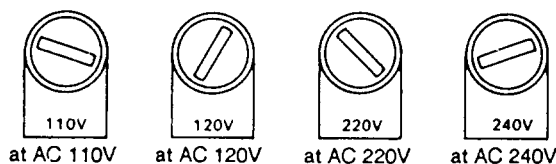

### 3. Procedures for replacement of flat packaged ICs

#### 1. Tools to be used:

- (1) **Soldering iron** . . . . Grounded soldering iron or soldering iron with leak resistance of 10 Mohms or more.

Form of soldering iron's tip:

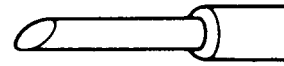

Fig. 2

- (2) **Magnifying glass** . . . for checking of finished works
- (3) **Tweezers** . . . . . for handling of IC and forming of leads
- (4) **Grounding ring** . . . . Countermeasure for electrostatic breakdown
- (5) **Nipper** . . . . . for removing defective IC
- (6) **Small brush** . . . . . for application of flux
- (7) **Enamel line**

#### 2. Work Procedures:

##### (1) Remove the defective IC

Cut all leads of the defective IC one by one using a nipper and remove the IC.

1. An enamel line has been pierced between the legs of the flat package IC.
2. Use a soldering iron to unsolder the legs one at a time.
3. Repeat the procedure of 1 and 2 above for the 3 sides only.

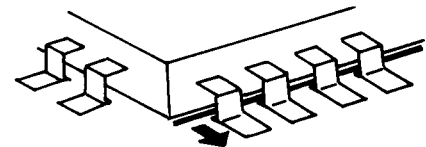

While holding the soldering against the enamel line, pull in the direction of the arrow.

##### (2) Clean the pattern surface of the PC board.

Get rid of the remaining leads and solder.

##### (3) Check and form the leads of the new flat packaged IC to be installed.

From every lead on the new IC using a pair of tweezers, so that all of them are aligned neatly without being risen, twisted or inclined toward one side. Especially the rising portion of every lead must be formed with greatest care.

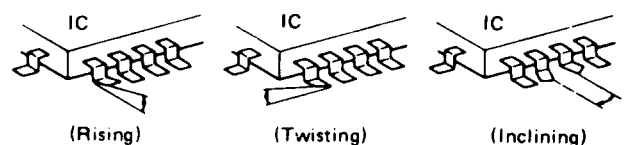

**(4) Apply flux to the PC board.**

Apply flux to the pattern surface of the PC board which has been cleaned, as shown in the illustration. The area to be applied with flux is the portion of about 2.5mm in width where the IC's leads are to be soldered.

Be careful to apply minimum amount of flux required so as not to smear it on unwanted areas.

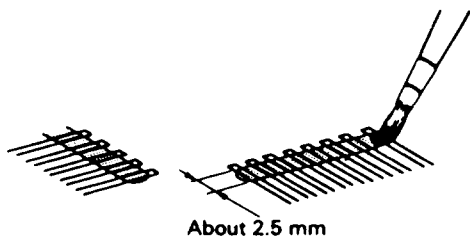
**(5) Temporarily tighten the IC**

Carefully align the pattern and IC's leads, so that the IC will be temporarily tightened to the pattern on the four leads at the corners. At this time, soldering is required, but no need to apply soldering material.

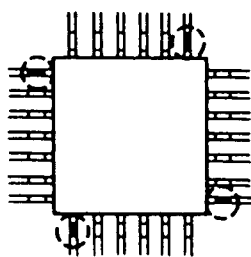
**(6) Apply flux to IC's leads**

Apply flux to the areas of IC's leads where soldering is to be performed. Be careful not to smear flux on the root portion of any lead or the body of IC.

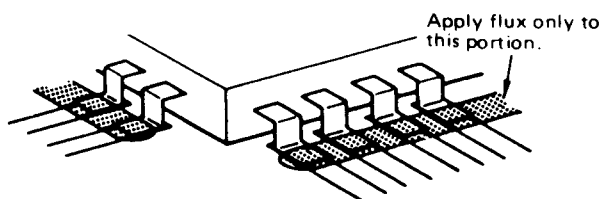
**(7) Soldering**

While attaching the tip of the soldering iron to the soldering point as shown in the illustration, feed 2-5mm of soldering wire. Then, slowly move the iron in the direction indicated by the arrow in the illustration, so that the leads will be soldered to the pattern. Move the iron in the rate of approximately 1cm in 5sec. Proceed with your work while confirming a clean fillet of solder is formed on each lead, subsequent to the melting of flux.

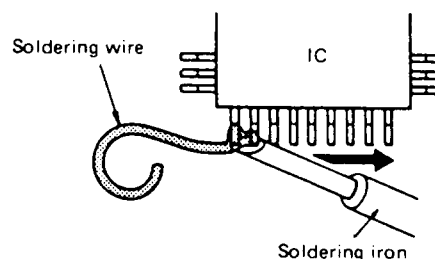
**CAUTION**

- 1) If you move the iron too quickly, loose soldering is likely to result.
- 2) Be especially careful when soldering the first lead where loose soldering is most liable to be formed.

**(8) Check the results**

When soldering of all leads is finished, check the soldered portion on every lead with a magnifying glass. A tester must not be used or checking of any soldered position

**3. Safety-check out (U.S.A. model)**

After correcting the original service problem, perform the following safety check before releasing the set to the customer:

Connect the insulating-resistance tester between the plug of power supply cable and chassis.



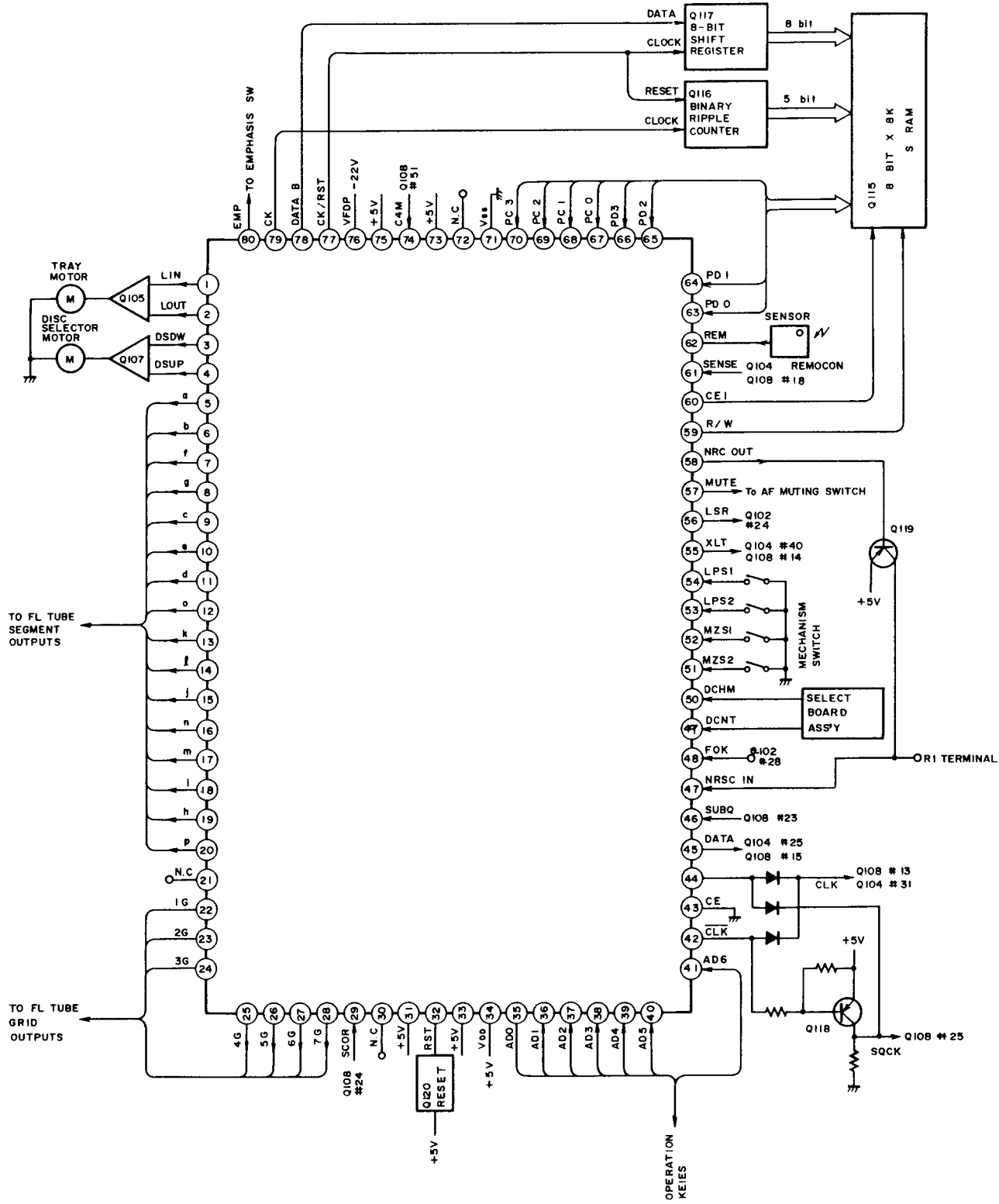

Specifications: more than 10Mohm at 500V.

# MICROPROCESSOR DESCRIPTIONS

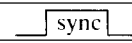
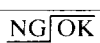

CONNECTION DIAGRAM

**Q114**  
**CXP50116H-105Q (Microprocessor) Terminal Description**

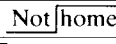
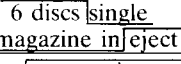
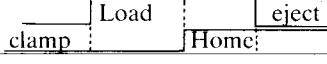
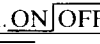
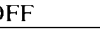
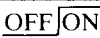
Pin No.	Symbol	Descriptions
1 2	LIN LOUT	Disc tray loading IN/OUT output terminals. Brake 
3 4	DSDW DSUP	Disc selector UP/DOWN output terminals.  Brake
5~20	a~p	Segment output terminals for FL tube.
22~28	1G~7G	Digit output terminals for FL tube.
29	SCOR	Subcode sync. SO+SI input terminal. 
32	RST	Reset input terminal.
34	V <sub>DD</sub>	Power supply terminal. Connect to 5V.
35~41	AD0~AD6	Key matrix input terminals. (A/D converter)
42 44	CLK	Serial clock output terminal. Subcode clock output terminal.
45	DATA	LSI control data serial output terminal.
46	SUBQ	Subcode Q data serial input terminal.
47	NRSC IN	RI code (Remote control code) input.
48	FOK	Focus OK input terminal. 
49	DCNT	Disc count pulse input terminal. 
50	DCMH	Disc selector home switch input. 
51 52	MZS2 MZS1	Magazine discrimination switch input terminals. 
53 54	LPS2 LPS1	Load position switch input. 
55	XLT	LSI control data latch pulse output.
56	LSR	Laser diode ON/OFF output terminal. 
57	MUTE	Audio muting output terminal. 
58	NRC OUT	RI code output terminal.
59	R/W	Read/Write command output terminal for Q115.
60	CE1	Chip enable
61	SENSE	LSI operation input terminal.
62	REM	Remote control code input terminal.
63~70	PD0~3, PC0~3	Memory data input/output terminals.
71	V <sub>SS</sub>	Connect to GND terminal.
74	C4M	Clock input terminal.
76	VFDP	Power supply terminal for predriver.
77	CK/RST	Clock/Reset output terminal.
78	DATA B	Data output terminal.
79	CK	Clock output terminal.
80	EMP	De-emphasis ON/OFF output. 

Pin No.	Symbol	Function	Pin No.	Symbol	Function
1	FSW	Time constant switching output terminal of output filter of spindle motor	49	RAW	Write enable signal output to external RAM
2	MON	ON/OFF control output terminal of spindle motor	50	RACS	Chip selector signal output to external RAM
			51	C4M	Divider output of crystal. f=4.2336MHz
3	MDP	Drive output terminal of spindle motor. Rough control when mode CLV-S and phase control when mode CLV-P	52	Vss	Ground
			53	XTAI	Input terminal of crystal oscillator
4	MDS	Drive output terminal of spindle motor. Speed control when mode CLV-P	54	XTAO	Output terminal of crystal oscillator
5	EFM	EFM signal input terminal from RF amplifier	55	MD1 ? MD3	Mode switching input terminals
6	ASY	Output terminal to control the slice level of EFM signal	57		
7	LOCK	GFS sampling terminal	58	SLOB	Code switching input of audio data output.
8	VCOO	VCO output terminal. 8.6436MHz when lock to EFM signal	59	PSSL	Mode switching input of audio data output. Serial output at low level. Parallel output at high level
9	VCOI	VCO input terminal	60	APTR	Control output for aperture correction. High level when Rch.
10	TEST	0V	61	APTL	Control output for aperture correction. High level when Lch.
11	PDO	Phase comparator output terminal of EFM signal and VCO/2	62	DA01	DA01 (LSB of parallel sound output) output when PSSL = H. C1F1 output when PSSL = L
12	Vss	Ground	63	DA02	DA02 output when PSSL = H. C1F2 output when PSSL = L.
13	CLK	Serial data transmitter clock input terminal from microcomputer	64	DA03	DA03 output when PSSL = H. C2F1 output when PSSL = L.
14	XLT	Latch input terminal from microcomputer	65	DA04	DA04 output when PSSL = H. C2F2 output when PSSL = L.
15	DATA	Serial data input terminal from microcomputer	66	DA05	DA05 output when PSSL = H. C2FL output when PSSL = L.
16	XRST	System rest input terminal. Reset at low level.	67	DA06	DA06 output when PSSL = H. C2PO output when PSSL = L.
17	CNIN	Tracking pulse input terminal	68	DA07	DA07 output when PSSL = H. RFCK output when PSSL = L.
18	SENS	Inner condition output terminal correspond to address	69	DA08	DA08 output when PSSL = H. WFCK output when PSSL = L.
19	MUTG	Muting input terminal	70	DA09	DA09 output when PSSL = H. PLCK output when PSSL = L.
20	CRCF	CRC check output terminal of subcode Q	71	DA10	DA10 output when PSSL = H. UGFS output when PSSL = L.
21	EXCK	Clock input terminal for serial output of subcode	72	DA11	DA11 output when PSSL = H. GTOP output when PSSL = L.
22	SBSO	Serial output terminal of subcode	73	V <sub>DD</sub>	Power supply (5V)
23	SUBQ	Subcode Q output terminal	74	DA12	DA12 output when PSSL = H. RAOV output when PSSL = L.
24	SCOR	Subcode sink S0 + S1 output terminal	75	DA13	DA13 output when PSSL = H. C4LR output when PSSL = L.
25	SQCK	Clock terminal to read the subcode Q	76	DA14	DA14 output when PSSL = H. C210 output when PSSL = L.
26	SQEX	Selector input terminal of SQCK	77	DA15	DA15 output when PSSL = H. C210 output when PSSL = L.
27	DOTX	Digital output terminal	78	DA16	DA16 (MSB of parallel sound output) output when PSSL = H. DATA output when PSSL = L
28	GFS	Indicator output of lock condition of frame sync	79	WDCK	Strobe signal output. 176.4kHz when DF is on. 88.2kHz when DF is off.
29	DB08 ? DB05	Data terminals of external RAM	80	LRCK	Strobe signal output. 88.2kHz when DF is on. 44.1kHz when DF is off.
32					
33	V <sub>DD</sub>	+5V			
34	DB04 ? DB01	Data terminals of external RAM			
37					
38	RA01 ? RA11	Address output terminals of external RAM			
48					

## ADJUSTMENT PROCEDURES

### Instruments Required

Dual trace oscilloscope, Frequency counter, AF signal generator, Test disc (SONY YEDS-18), AC voltmeter, Jitter meter, and Socket P4 (Part no. 25050138)

### 1. VCO Frequency Adjustment

Connect the frequency counter to terminal P110.

Turn the power switch to ON. (No load the disc.)

Adjust R154 so that the frequency counter reading becomes  $4322 \pm 5\text{kHz}$ .

After adjustment, disconnect the frequency counter.

Mode: STOP

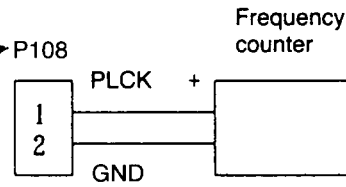

### 2. RF Offset Adjustment

Connect the oscilloscope to terminal P106.

Adjust R192 so that the RF signal becomes  $100\text{mV} \pm 30\text{mV}$ .

Mode: STOP

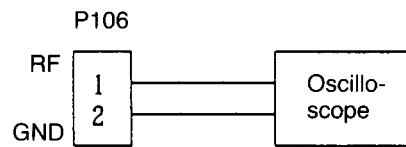

### 3. Tracking Balance Adjustment

Turn R108 clockwise  $45^\circ$  from the mechanical center.

Connect the oscilloscope to terminal P107 TR.

Adjust R195 so that the TR signal becomes  $0 \pm 30\text{mV}$ .

Turn R108 to the mechanical center.

Mode: STOP

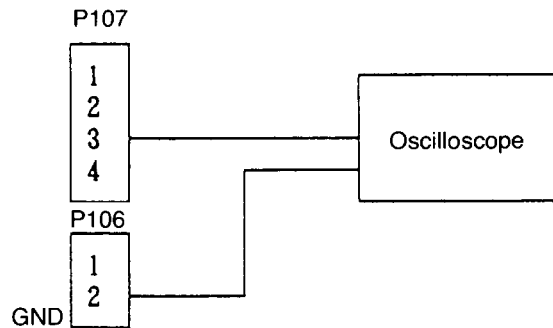

### 4. Focus Offset Adjustment

Load the test disc YEDS-18 on the tray and play the track 2.

Connect the oscilloscope or jitter meter to terminal P106.

(Oscilloscope)

Adjust R110 until a clear trace of waveform pattern as shown photo 1 appear on the oscilloscope.

When the amount of jitter is broad, set R110 to mechanical center.

(Jitter meter)

Adjust R110 until the jitter meter reading becomes minimum. (Less than  $10\text{ns}$ .)

After adjustment, disconnect the oscilloscope or jitter meter.

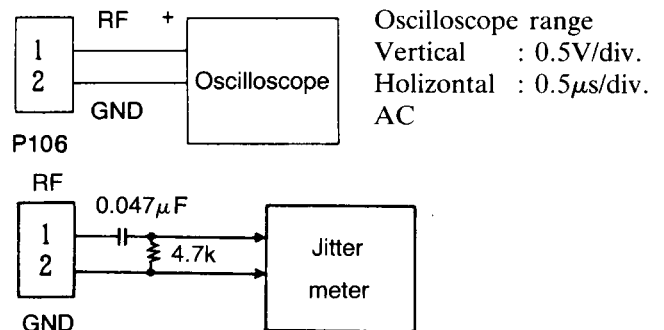
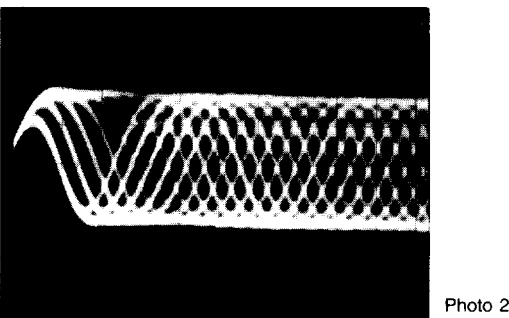

### 5. Tracking Offset Adjustment

Load the test disc YEDS-18 on the tray and play the track 2. Turn R132 to minimum position. (Counter clockwise)

Connect the oscilloscope between pin 3 (TR) of P107 and pin 2 (GND) of P106.

Adjust R108 until the center of tracking error signal on the oscilloscope becomes GND level.

Turn R132 to the mechanical center.

After adjustment, disconnect the oscilloscope.

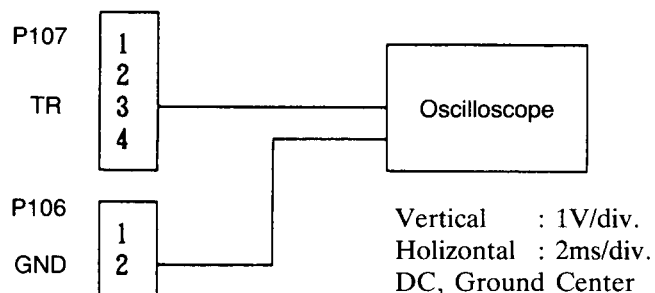
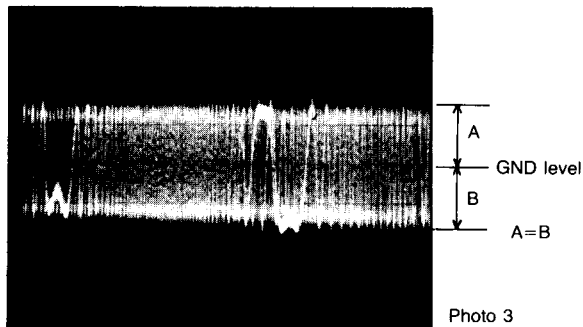

### 6. Focus Gain Adjustment

Set the output of AF signal generator to 800Hz, 1~1.5Vp-p.

Play the track 2 of test disc.

Connect the oscilloscope and the AF signal generator as shown below.

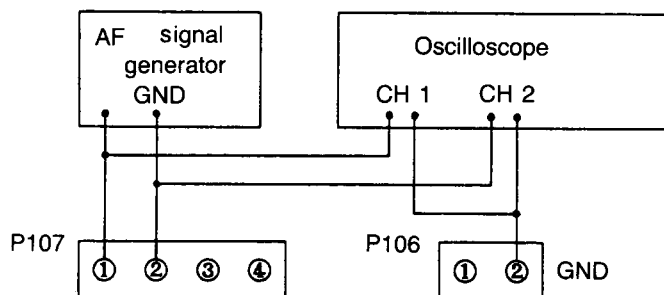
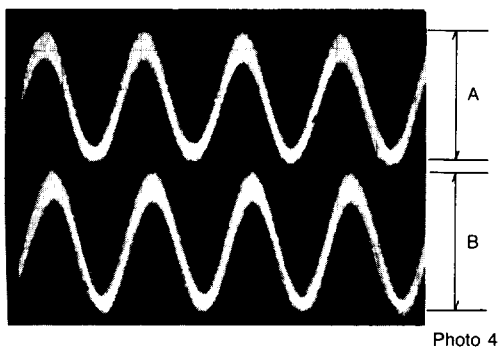

Adjust R122 until 800Hz components of channels 1 and 2 on oscilloscope become same level.

After adjustment, disconnect the AF signal generator and the oscilloscope.

### 7. Tracking Gain Adjustment

Set the output of AF signal generator to 1.2kHz, 1~1.5Vp-p.

Play the track 2 of test disc.

Connect the oscilloscope and the AF signal generator oscillator as shown below.

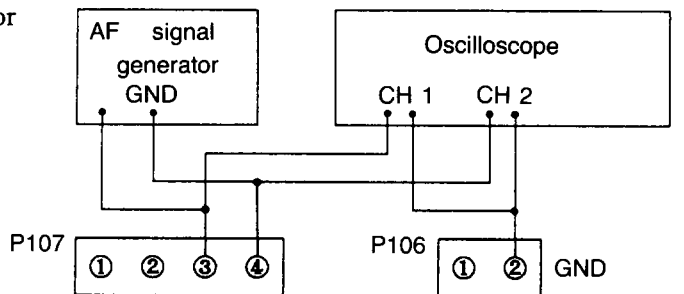
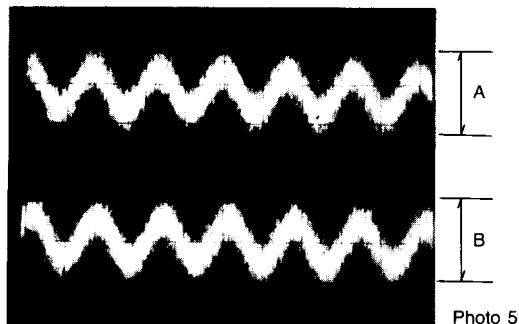



Adjust R125 until 1.2kHz components of channels 1 and 2 on oscilloscope become same level.

After adjustment, disconnect the AF signal generator and the oscilloscope.

After adjustment, confirm that the center of tracking error signal becomes GND level.

### 8. Audio circuit adjustment

Connect the AC voltmeter to output terminal of left channel (right channel).

Load the test disc and play the track 2.

Next, play the track 17.

Adjust R207 (R208) so that the output discrepancy between track 2 and track 17 is  $60 \pm 0.25\text{dB}$ .

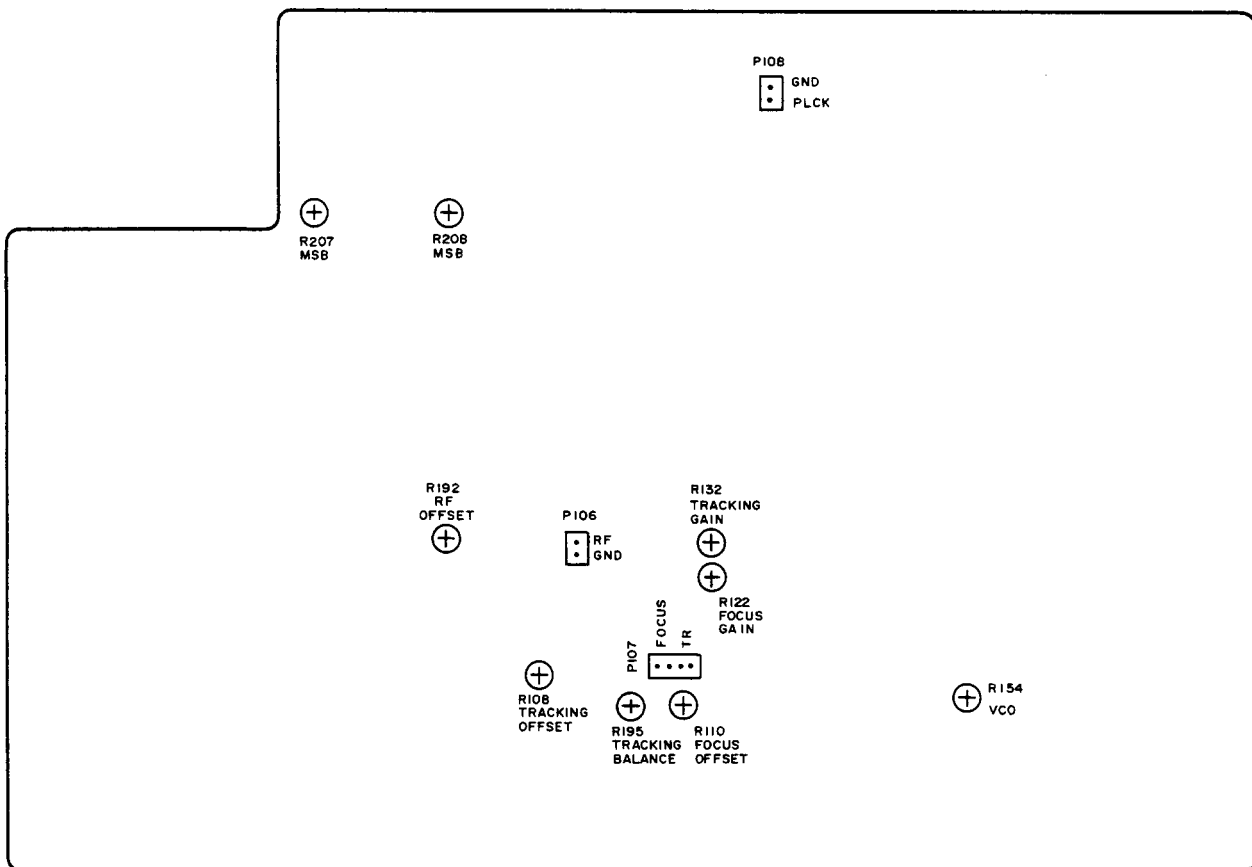

**ADJUSTMENT POINT**

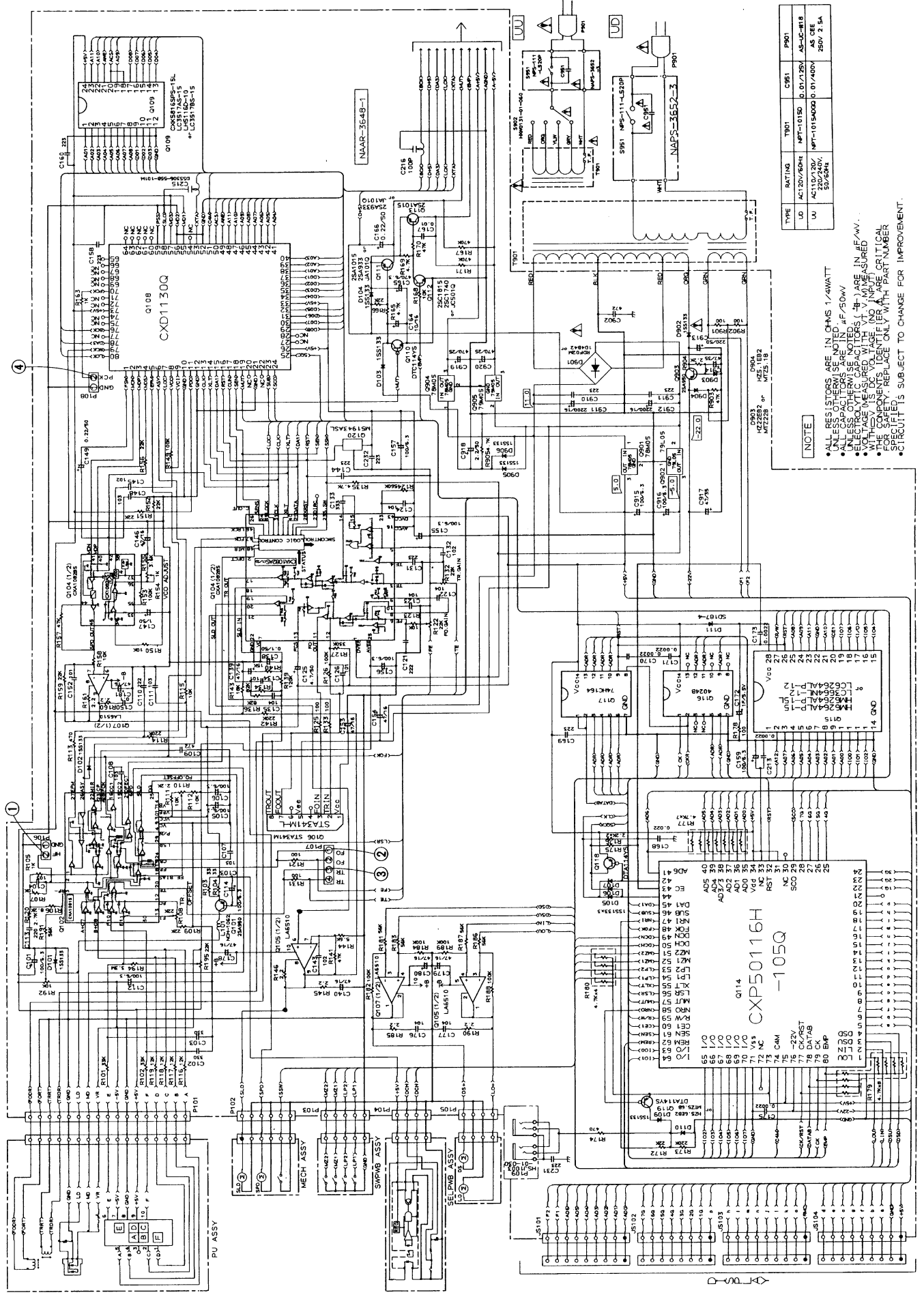

TYPE	RATING	T801	C951	P901
UD	AC120V/60Hz	MPT-10150	D. 01/25	AS-LC-R18
UU	AC110V/200VA/50/60Hz	MPT-10150000	D. 01/AD0V	AS CEE
				250V 2.5A

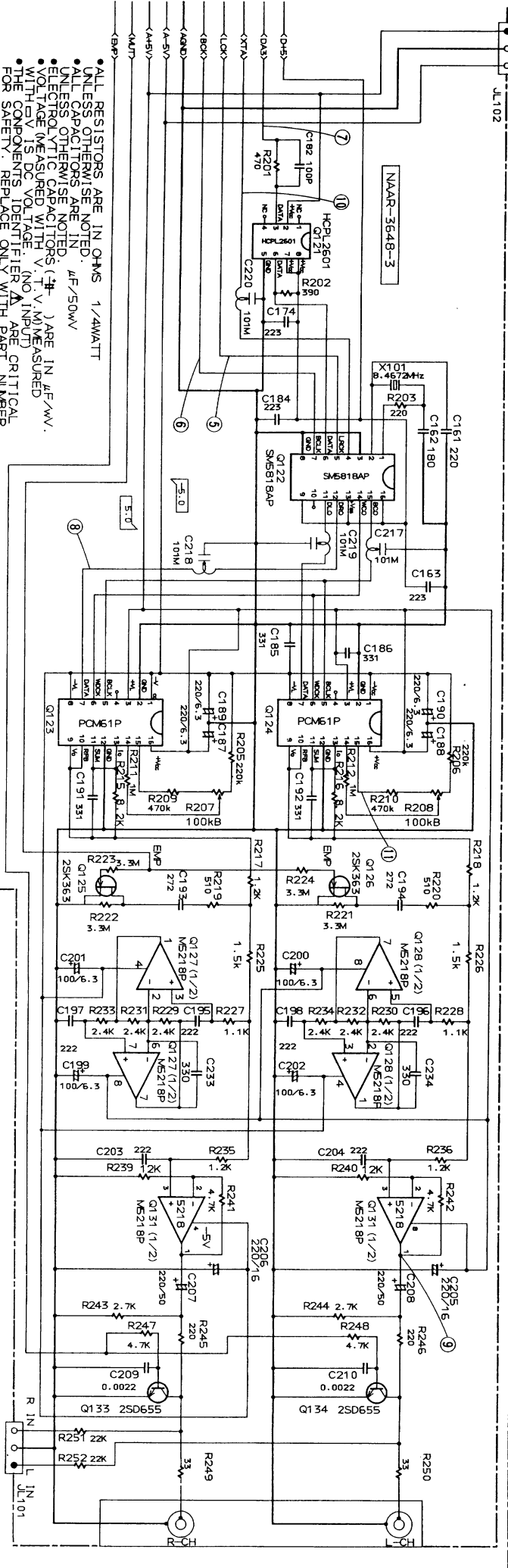
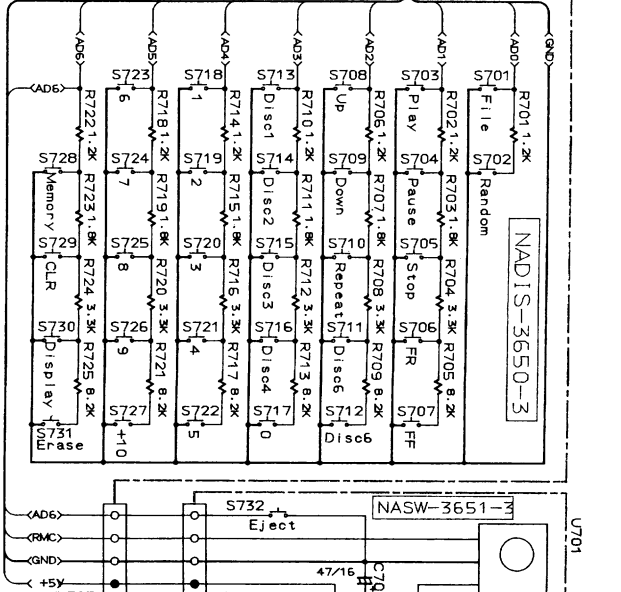
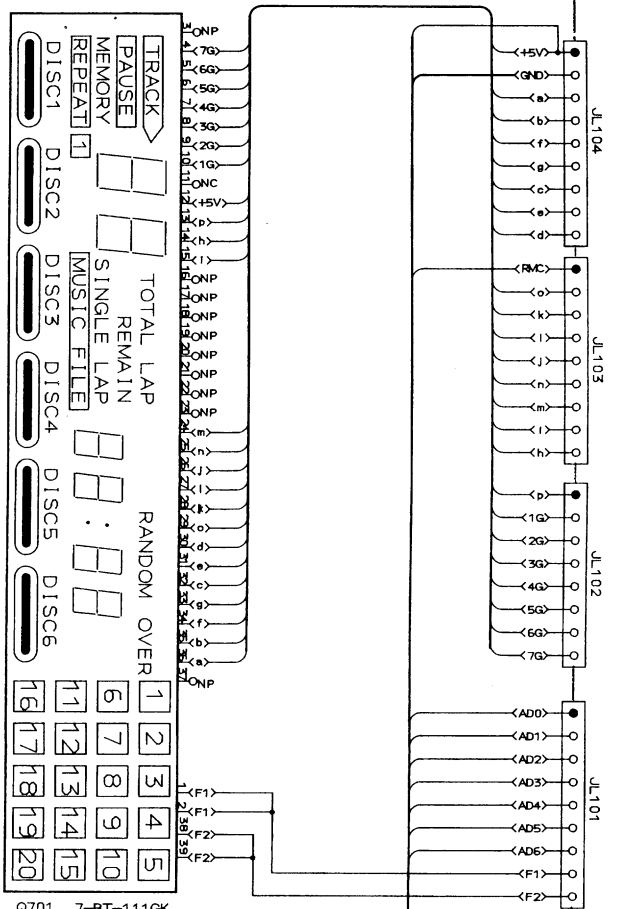
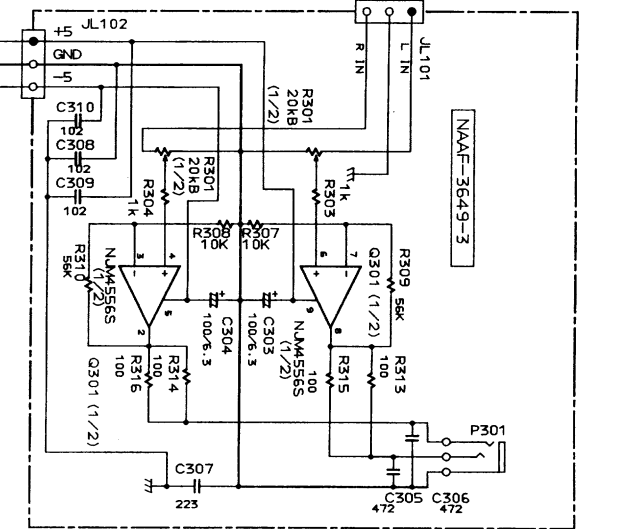

• ALL RESISTORS ARE IN OHMS 1/4WATT  
 • UNLESS OTHERWISE NOTED.  
 • ALL CAPACITORS ARE IN pF/50WV  
 • UNLESS OTHERWISE NOTED.  
 • ELECTROLYTIC CAPACITORS (E) ARE IN uF/WV.  
 • VOLTAGE MEASURED WITH V.T.V.(M) MEASURED  
 • WITHEAGE MEASURED WITH V.T.V.(M) MEASURED  
 • THE COMPONENTS IDENTIFIED WITH A PART NUMBER  
 • FOR SAFETY. REPLACE ONLY WITH PART NUMBER  
 • SPECIFIED.  
 • CIRCUIT IS SUBJECT TO CHANGE FOR IMPROVEMENT.

# PRINTED CIRCUIT BOARD PARTS LIST

## MAIN CIRCUIT PC BOARD (NAAR-3648-3)

CIRCUIT NO.	PART NO.	DESCRIPTION	CIRCUIT NO.	PART NO.	DESCRIPTION
<b>ICs</b>			Q901	222780052	78M05
Q102	22240180	CXA1081S	Q902	222790053	79L05
Q104	22240263	CXA1082BS	Q904	222780055MIT	M5F78M05
Q105, Q107	22240034	LA6510	Q905	222790055MIT	M5F79M05
Q106	22240168	STA341M-L	<b>Transistors</b>		
Q108	22240095	CXD1130Q	Q101, Q903	2211503 or 2211504	2SA950-O or 2SA950-Y
Q109	22240178, 22240118, 22240234 or 22240255	CXK5816SPS-15L, LC3517AS-15, LC3517BS-15 or LH5116D-10	Q110	221281	DTC114YS
Q114	22240306	CXP50116H-105Q	Q111, Q113	2211454, 2211455, 2213074 or 2212495	2SA1015-Y, 2SA1015-GR, 2SA933-R or JA101-Q
Q115	22240199, 22240217, 22240198 or 22240232	HM6264ALP-15, HM6264ALP-15L, LC3664NL-12 or LC6264ALP-12	Q112	2211254, 2211255, 2211183 or 2212485	2SC1815-Y, 2SC1815-GR, 2SC1740-R or JC501-Q
Q116	222840241	4024B	Q118, Q119	2213090	DTA114YS
Q117	222741645	74HC164	Q125, Q126	2212524 or 2212525	2SK363-GR or 2SK363-BL
Q120	22240018	M51943ASL	Q133, Q134	2211705 or 2211706	2SD655-E or 2SD655-F
Q122	22240362	SM5818AP	<b>Photo coupler</b>		
Q123, Q124	22240324	PCM61P	Q121	226027	HCPL2601
Q127, Q128	222808 or	M5218P or	<b>Diodes</b>		
Q131	22240369	M5218AP	D101-D107	223163	1SS133
			D109, D902	223163	1SS133
			D110	224650562 or 224450562	HZ5.6EB2 or MTZ5.6B
			D111	223191	SD101
			D901	22380013 or 22380039	RDF02M or 1D4B42

CIRCUIT NO.	PART NO.	DESCRIPTION	CIRCUIT NO.	PART NO.	DESCRIPTION
D903	224652202 or 224452202	HZ22EB2 MTZ22B	C149	354782299	0.22 $\mu$ F, 50V, Elect.
D904	224650512 or 224450512	HZ5.1EB2 or MTZ5.1B	C150	371121044	0.1 $\mu$ F 5%, 50V, Mylar
D905, D906	223163	1SS133	C153, C154	354744709	47 $\mu$ F, 16V, Elect.
X101	<b>X'tal</b> 3010153	KD3913FFA	C155-C157	354721019	100 $\mu$ F, 6.3V, Elect.
L101	<b>Coil</b> 231023	NCH-1062	C159	354721019	100 $\mu$ F, 6.3V, Elect.
C101	<b>Capacitors</b> 354721019	100 $\mu$ F, 6.3V, Elect.	C164	354741009	10 $\mu$ F, 16V, Elect.
C104	371121034	0.01 $\mu$ F 5%, 50V, Mylar	C165	354724719	470 $\mu$ F, 6.3V, Elect.
C105, C106	354721019	100 $\mu$ F, 6.3V, Elect.	C166	354782299	0.22 $\mu$ F, 50V, Elect.
C107, C108	371121034	0.01 $\mu$ F 5%, 50V, Mylar	C167	371121034	0.01 $\mu$ F 5%, 50V, Mylar
C109	371124724	4700pF 5%, 50V, Mylar	C172	3000058	1F, 5.5V, Super
C110	371126824	6800pF 5%, 50V, Mylar	C176, C177	371121044	0.1 $\mu$ F 5%, 50V, Mylar
C111	371121034	0.01 $\mu$ F 5%, 50V, Mylar	C178-C181	354744709	47 $\mu$ F, 16V, Elect.
C112, C114	354721019	100 $\mu$ F, 6.3V, Elect.	C183	354721019	100 $\mu$ F, 6.3V, Elect.
C121	371122224	2200pF 5%, 50V, Mylar	C187-C190	354722219	220 $\mu$ F, 6.3V, Elect.
C122, C123	371121044	0.1 $\mu$ F 5%, 50V, Mylar	C191, C192	373303314	330pF 5%, 125V, Plastic (PP)
C124	371121034	0.01 $\mu$ F 5%, 50V, Mylar	C193, C194	371122734	0.027 $\mu$ F 5%, 50V, Mylar
C125	354780479	4.7 $\mu$ F, 50V, Elect.	C195-C198	371122224	2200pF 5%, 50V, Mylar
C131	371122234	0.022 $\mu$ F 5%, 50V, Mylar	C199-C202	354721019	100 $\mu$ F, 6.3V, Elect.
C132	371121024	1000pF 5%, 50V, Mylar	C203, C204	371122224	2200pF 5%, 50V, Mylar
C133	371123334	0.033 $\mu$ F 5%, 50V, Mylar	C205, C206	354742219	220 $\mu$ F, 16V, Elect.
C135	371121044	0.1 $\mu$ F 5%, 50V, Mylar	C207, C208	354782219	220 $\mu$ F, 50V, Elect.
C138	354781099	0.1 $\mu$ F, 50V, Elect.	C209, C210	371122224	2200pF 5%, 50V, Mylar
C139	354744709	47 $\mu$ F, 16V, Elect.	C228	354721019	100 $\mu$ F, 6.3V, Elect.
C140	352944706	47 $\mu$ F, 16V, Non-polar elect.	C911, C912	354742229	2200 $\mu$ F, 16V, Elect.
C143	371121024	1000pF 5%, 50V, Mylar	C913	354782219	220 $\mu$ F, 50V, Elect.
C146	354744709	47 $\mu$ F, 16V, Elect.	C914, C917	354764709	47 $\mu$ F, 35V, Elect.
C147	354780109	1 $\mu$ F, 50V, Elect.	C915, C916	354721019	100 $\mu$ F, 6.3V, Elect.
C148	371121034	0.01 $\mu$ F 5%, 50V, Mylar	C918	354780229	2.2 $\mu$ F, 50V, Elect.
			C919, C920	354754719	470 $\mu$ F, 25V, Elect.

CIRCUIT NO.	PART NO.	DESCRIPTION
	<b>Filters</b>	
C215-C220	3030002	DSS306-55B-101M
	<b>Resistors</b>	
R108, R195	5210066	N06HR22KBD, Semi-fixed
R110	5210060	N06HR2.2KBD, Semi-fixed
R122, R132	5210066	N06HR22KBD, Semi-fixed
R154	5210058	N06HR1KBD, Semi-fixed
R177	49121472407	4.7kohm $\times$ 7, 1/8W, Network
R179	49163472408	4.7kohm $\times$ 8, 1/10W, Network
R180	49121472404	4.7kohm $\times$ 4, 1/8W, Network
R192	5210064 or 5210217	N06HR10KBD, Semi-fixed
R207, R208	5210070 or 5210221	N06HR100KBD, Semi-fixed
	<b>Plugs</b>	
P102	25055426	NPLG-6P408
P103	25055149	NPLG-5P133
P104	25055148	NPLG-4P132
P105	25055424	NPLG-4P406
P106, P108	25055038	NPLG-2P29
P107	25055045	NPLG-4P33
	<b>Terminals</b>	
P109	25045172	HSJ1003-01-020, R1 output/input
P110	25045259	NPJ-2PDBL128, Output
	<b>Sockets</b>	
P101	25050360	NSCT-17P187
JS101, JS103	25050273	NSCT-9P101
JS104	25050273	NSCT-9P101
JS102	25050272	NSCT-8P100
	<b>Radiator</b>	
	27160176	RAD56
	<b>Screw</b>	
	82143006	3P+6FN(BC), Pan head

**HEADPHONE AMPLIFIER PC BORAD (NAAF-3649-3)**

CIRCUIT NO.	PART NO.	DESCRIPTION
	<b>IC</b>	
Q301	222887	NJM4556S
	<b>Capacitors</b>	
C303, C304	354721019	100 $\mu$ F, 6.3V, Elect.
	<b>Resistor</b>	
R301	5104248	N09RGL20KB20F, Variable
	<b>Jack</b>	
P301	25045256	YKB21-5010

**DISPLAY CIRCUIT PC BOARD(NADIS-3650-3)**

CIRCUIT NO.	PART NO.	DESCRIPTION
	<b>FL tube</b>	
Q701	212078	7-BT-111GK
	<b>Switches</b>	
S701-S731	25035548	NPS-111-S510
	<b>Holder</b>	
	27190696	FL tube

**REMOCON SENSOR TERMINAL PC BOARD (NASW-3651-3)**

CIRCUIT NO.	PART NO.	DESCRIPTION
U701	24130001 or 24130003	GPIU501S or GPIU50XS, Remocon sensor
C701	354744709	47 $\mu$ F, 16V, Elect. capacitor
S732	25035548	NPS-111-S510, Push switch

**POWER SUPPLY PC BOARD(NAPS-3652-3)**

CIRCUIT NO.	PART NO.	DESCRIPTION
C951	3500065A	$\triangle$ DE7150FZ103P AC400V/125V, Capacitor IS
S951	25035558	$\triangle$ NPS-111-L520P, Power switch

NOTE: THE COMPONENTS IDENTIFIED BY MARK  $\triangle$  ARE CRITICAL FOR RISK OF FIRE AND ELECTRIC SHOCK REPLACE ONLY WITH PART NUMBER SPECIFIED.

## PARTS LIST

REF.NO.	PART NO.	DESCRIPTION	REF.NO.	PART NO.	DESCRIPTION
1	24602505	Belt	69	25065376	Slide switch (INSIDE)
2	24506795	Stair L	70	<del>24506840</del>	Spindle motor
3	24506796	Stair R	71	24506841	Pickup ass'y
4	24506797	Gear pulley	72	801423	Screw
5	24506798	Gear	73	82112003	2P+3F, Pan head screw
6	24506799	Gear	74	24506842	Carriage motor
7	24506800	Gear	75	<del>24506843</del>	Disc table ass'y
8	24506801	Idler gear	101	24506845	Main chassis
9	24503167	Spring, eject	102	24506846	Gear bracket L
10	24503168	Spring, lock	103	24506847	Gear bracket R
11	24503169	Spring SM	104	24506848	Lever
12	24503170	Spring, stair	105	24506849	Select SM
13	24503171	Spring, drive	106	24506850	Eject lever
14	24506807	Steelball	107	24506851	Drive lever
15	24506808	Rack	108	24506852	Bottom guide
16	24506809	Drive plate	109	24506853	Sub chassis
17	24506810	Operation plate	110	24506854	Upper chassis
18	24506811	Top guide	111	24506855	Upper guide
19	24506812	Lock lever	112	24506856	Switch pc board ass'y
20	24506813	Idler roller	113	24506857	Select pc board ass'y
21	24506814	Damper ass'y	114	24506858	Base pc board
22	801419	Motor mounting screw	115	24506859	Carriage motor ass'y
23	801420	Float screw	116	24506860	Servo mechanism ass'y
24	24503172	Clamper spring T	117	24506861	Roller
25	24503173	Clamper spring B			
26	24509400	Float rubber			
27	28140978	Cushion A			
28	28140979	Cushion B			
29	24506822	Clamper			
30	24506823	Rotary lever			
31	24506824	Clamper cam			
32	24506825	Clamper holder T			
34	24506826	Clamper holder B			
35	24506827	Pressure cam			
36	24506828	Upper tray			
38	838120088	2TTB+8B, Pan head screw			
39	801421	3TTB+6B(BC), Pan head screw			
40	838130068	3TTB+6B, Tapping screw			
41	838130068	3TTB+6B, Tapping screw			
42	838130068	3TTB+6B, Tapping screw			
43	838130068	3TTB+6B, Tapping screw			
44	838130068	3TTB+6B, Tapping screw			
45	838130068	3TTB+6B, Tapping screw			
46	833130049	3TTP+4C, Tapping screw			
47	260208	Binder			
48	82112003	2P+3F, Pan head screw			
49	833130080	3TTP+8P, Tapping screw			
50	8771301210	W3×12, Washer			
51	870085	Washer			
52	870085	Washer			
53	27270295	Washer			
54	27270132	Washer			
55	27270294	Washer			
56	27270294	Washer			
57	27270296	Washer			
58	24506829	Motor ass'y (LOADING/DISC SELECT)			
59	335011047	0.1 μF, 25V, Ceramic capacitor			
60	801422	Screw			
61	24503174	Drive spring			
62	24503175	Spring			
63	24602506	Belt			
64	24506834	Drive screw			
6	24506835	Guide bar			
<u>66</u>	<u>24506836</u>	<u>Chassis</u>			
67	24506837	Carriage plate			
68	24506838	Pulley			

MECHANISM-EXPLODED VIEW

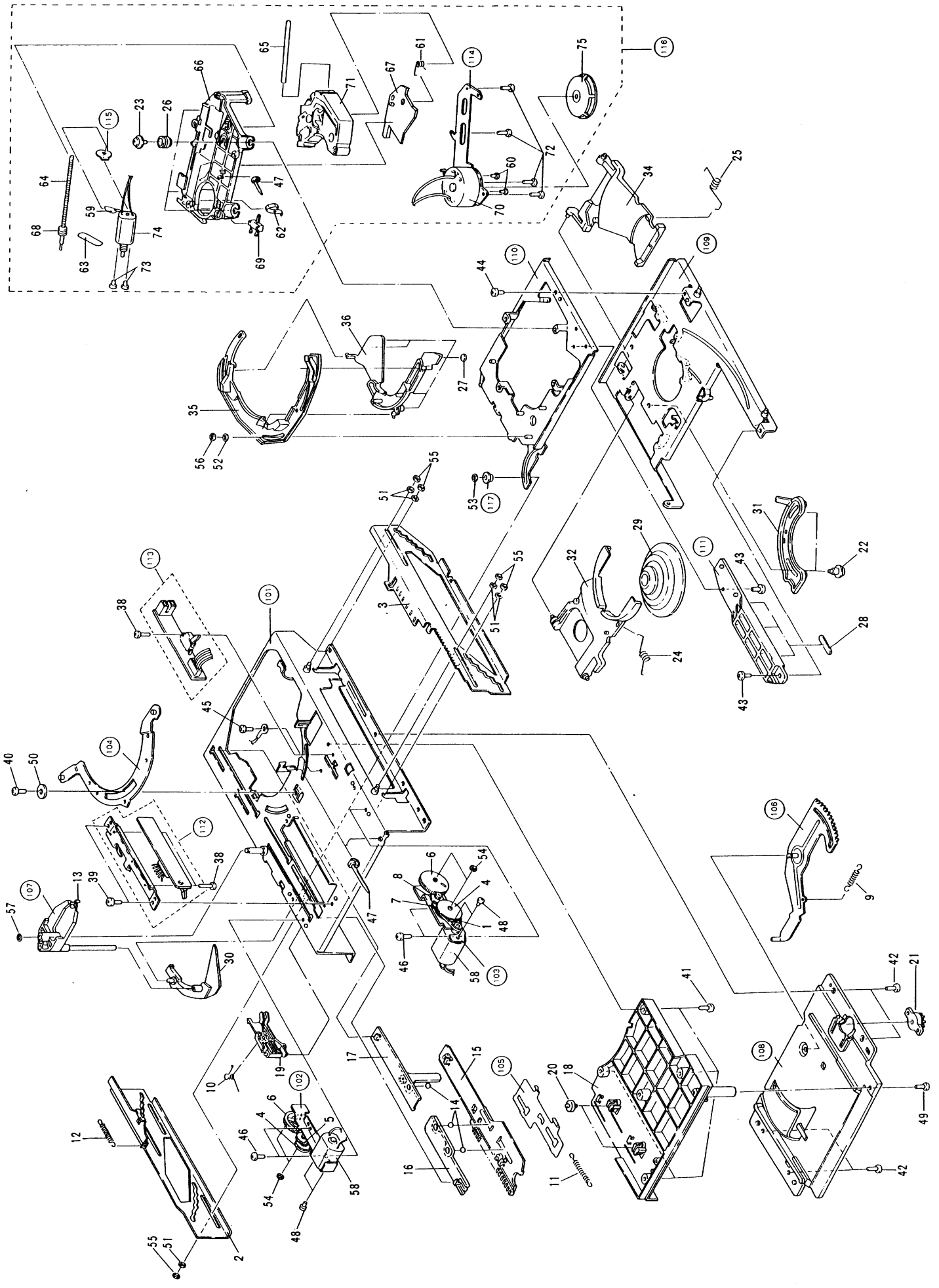



**EXPLODED VIEW**

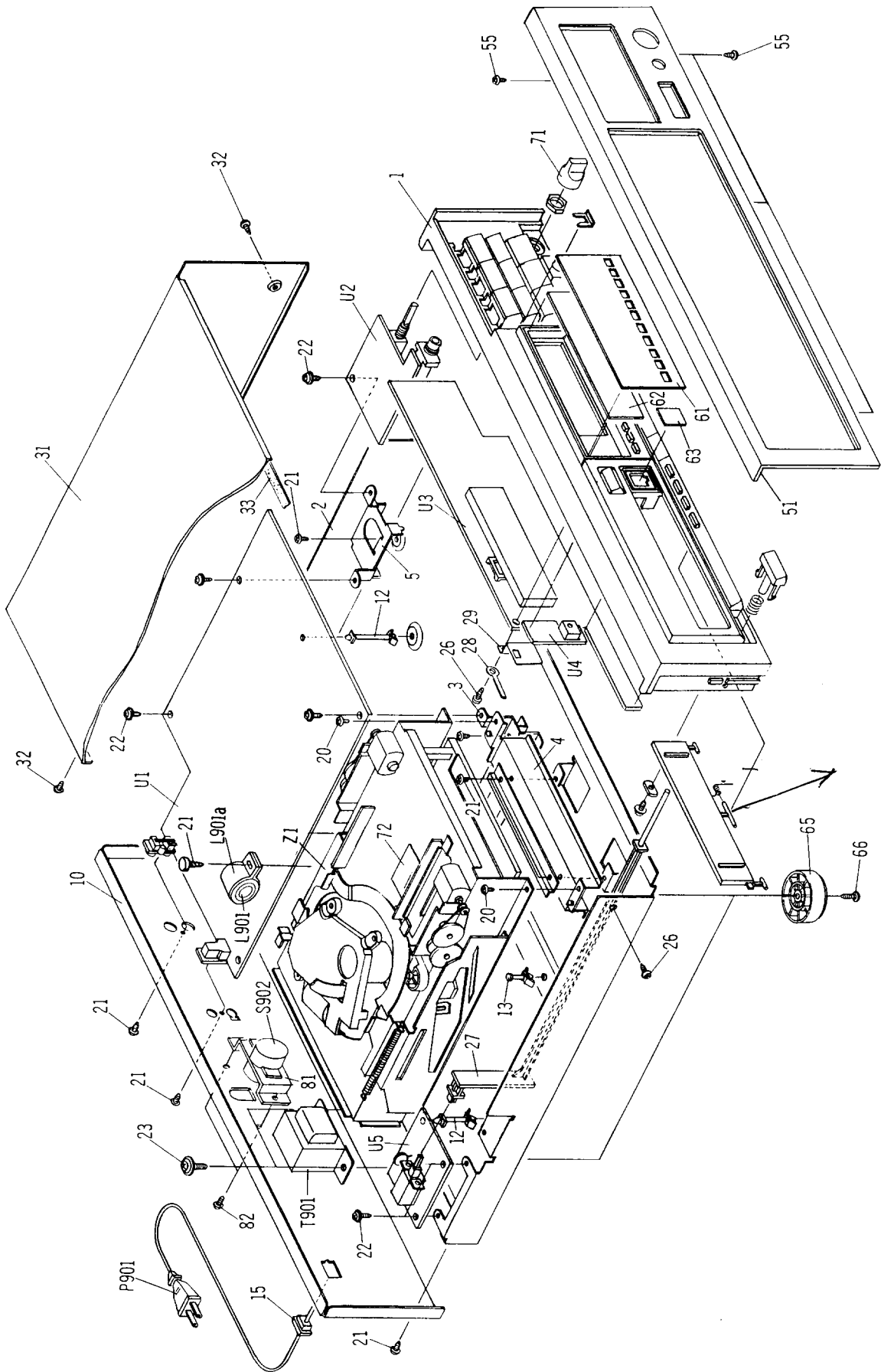

## PARTS LIST

REF. NO.	PART NO.	DESCRIPTION	REF. NO.	PART NO.	DESCRIPTION
1	27110576A	Front bracket ass'y	U1	IHI27548-3	NAAR-3648-3, Main circuit pc board ass'y
2	27100196A	Chassis	U2	IHI27549-3	NAAF-3649-3, Headphone amplifier pc board ass'y
3	27130586	Bracket, center	U3	IHI27550-3	NADJS-3650-3, Display circuit pc board ass'y
4	27130587	Bracket F	U4	IHI27551-3	NASW-3651-3, Remocon sensor terminal pc board ass'y
5	27141345	Bracket PC	U5	IHI27552-3	NAPS-3652-3, Power supply circuit pc board ass'y
10	27121362-1	Back panel <D>	Z1	24506789 260208	NCD-100P-Pic, Mechanism ass'y Binder
12	27121362-1	Back panel <W>			
13	27190470	KGLS-18S, Holder			
15	27190724	KGPS-12S, Holder			
20	27300750	△ Bushing(strainrelief)			
21	834430068	3TTS+6B(BC), Tapping screw			
22	834430088	3TTS+8B(BC), Tapping screw			
23	831130088	3TTW+8B, Tapping screw			
24	830440069	4TTC+ 6 C(BC), Tapping screw			
25	834430108	3TTS+10B(BC), Tapping screw			
26	833426060	2.6TTP+6P(BC), Tapping screw			
27	833430080	3TTP+8P(BC), Tapping screw			
28	27273123A	Joint, power			
29	27255004	CS-1U, Clip			
31	27150284	Shield plate (Mechanism)			
32	2818445A	Top cover			
33	834430088	3TTS+8B(BC), Tapping screw			
41	28140720	Cushion			
51	27270214A	Spacer			
55	IHI27121	Front panel ass'y			
61	833430080	3TTP+8P(BC), Tapping screw			
62	28191523	Clear plate			
63	28133229	Back plate			
65	27262512	Plate			
66	27175153	Leg			
71	834430088	3TTS+8B(BC), Tapping screw			
72	28323571	Knob LEVEL			
81	29360807	Label DANGER			
82	27141090A	Bracket U <W>			
L901	834430088	3TTS+8B(BC), Tapping screw <W>			
L901a	230908	TR-23-11-14, Core <D>			
P901	260223	NK-10N, Clamp <D>			
	253112A	△ AS-UC-4#18, Power supply cord <D>			
S902	253148 or 253150	△ AS-CEE, Power supply cord <W>			
T901	25065168	△ HXW0131-01-060, Voltage selector switch <W>			
	2300384B	△ NPT-1015D, Power transformer <D>			
	2300387B	△ NPT-1015ADGQ, Power transformer <W>			

NOTE: <D>: Only 120V model  
<W>: Only Worldwide model

NOTE: THE COMPONENTS IDENTIFIED BY MARK △ ARE CRITICAL FOR RISK OF FIRE AND ELECTRIC SHOCK. REPLACE ONLY WITH PART NUMBER SPECIFIED.

# WAVEFORM OF EACH SECTION

**Note:** The encircled numbers denote measuring points in the schematic diagram.

Play the track 2 of test disc YEDS-18.

Use the high impedance probe (10:1)

- ① RF signal  
0.5 $\mu$ s/div.  
1V/div.

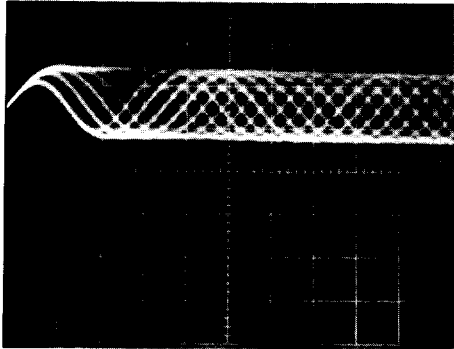

- ② Focus error signal  
5ms/div.  
200mV/div.

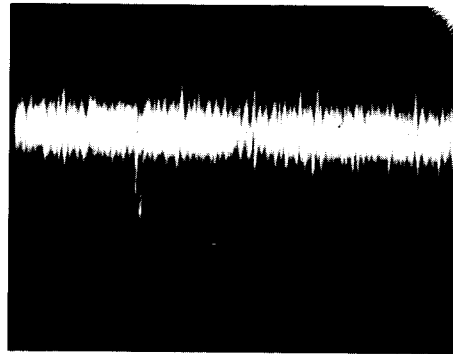

- ③ Tracking error signal  
5ms/div.  
0.5V/div.



- ④ PLCK  
0.2 $\mu$ s/div.  
2V/div.

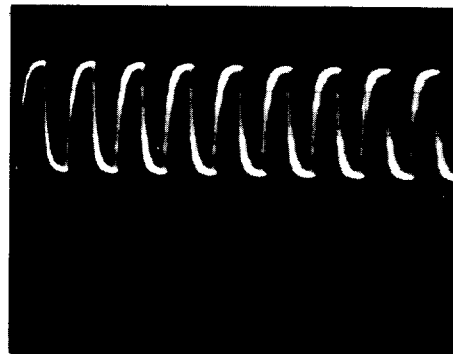

- ⑤ LRCK  
Q122 #5  
10 $\mu$ s/div.  
2V/div.

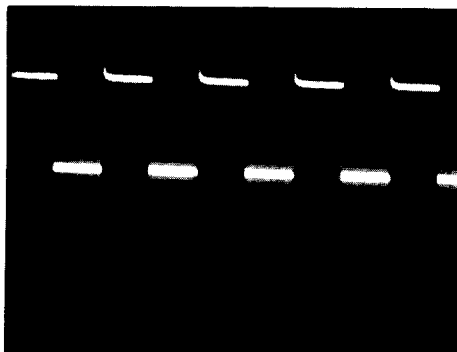

- ⑥ BCLK  
Q122 #7  
0.2 $\mu$ s/div.  
1V/div.

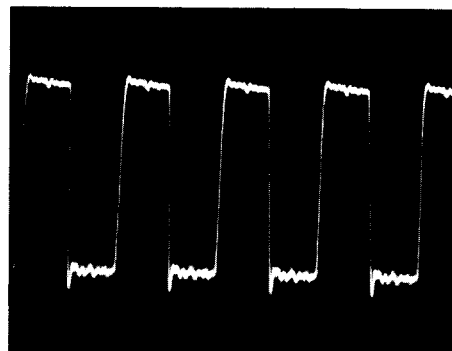

⑦ DATA  
Q122 #6  
0.2 $\mu$ s/div.  
1V/div.

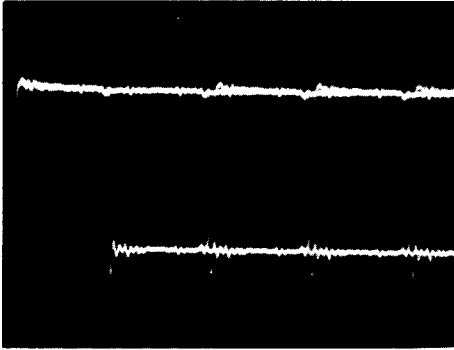

⑧ Q122 #11/#12  
0.2 $\mu$ s/div.  
2V/div.

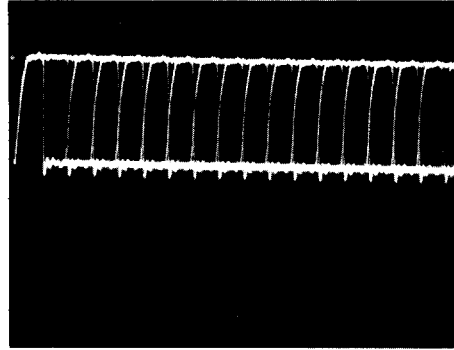

⑨ Q131 #1  
1ms/div.  
2V/div.

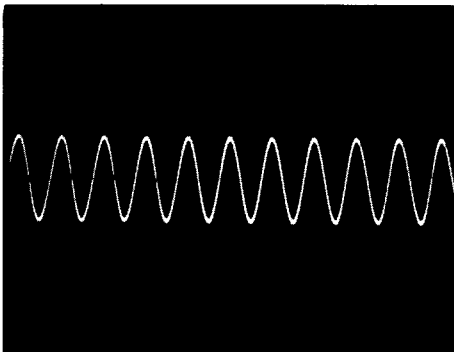

⑩ Q122 #4  
0.1 $\mu$ s/div.  
2V/div.

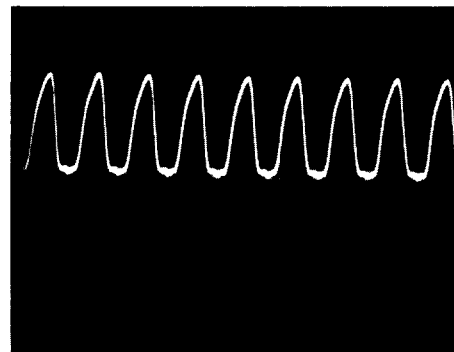

⑪ Q124 #15  
2 $\mu$ s/div.  
2V/div.

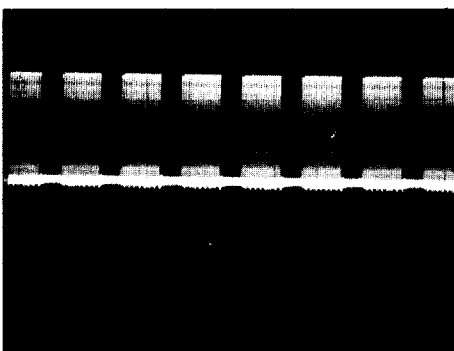

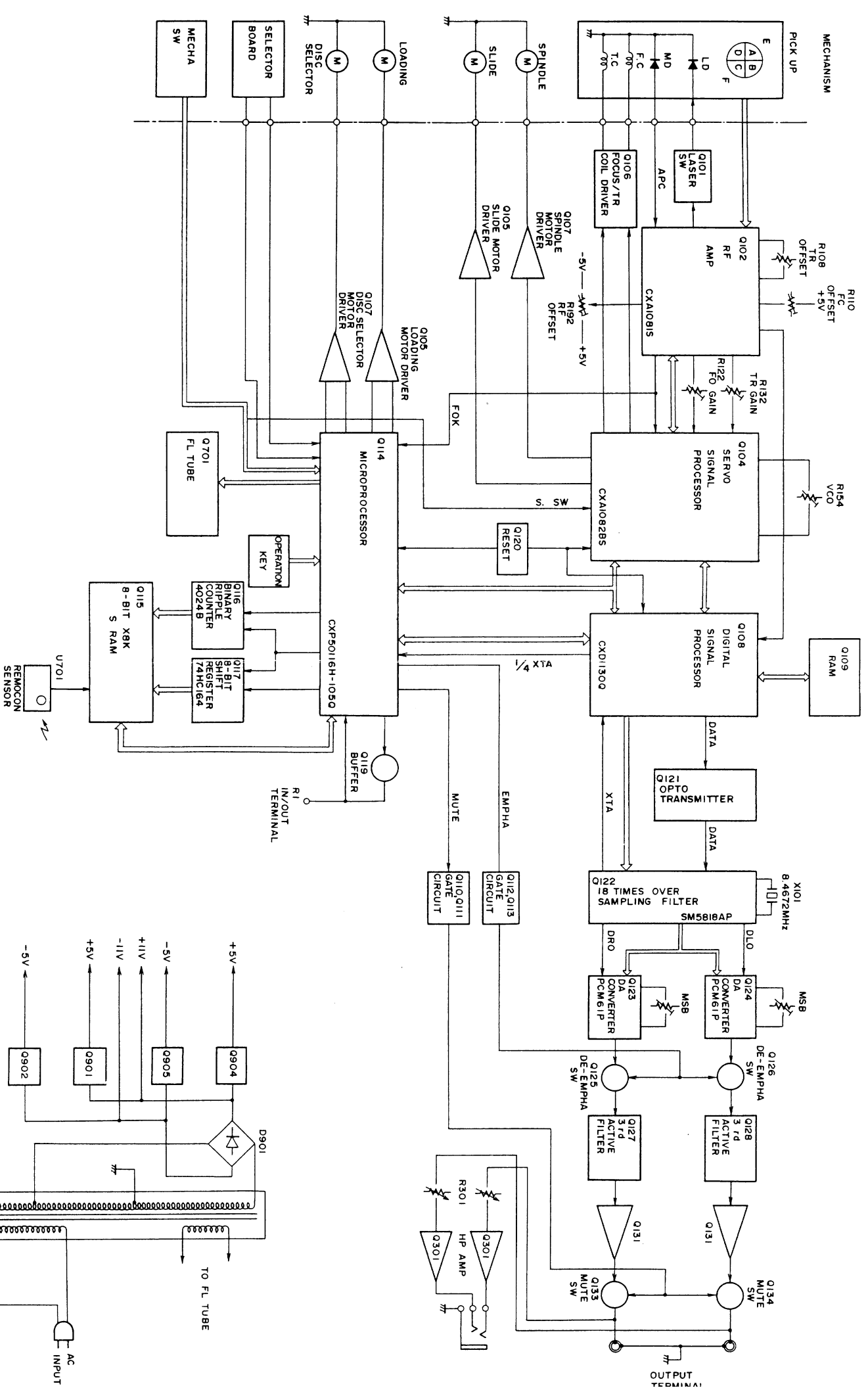

## CAUTION ON REPLACEMENT OF PICK-UP

The laser diode in the optical pick-up block is so sensitive to static electricity, surge current and etc. that the components are liable to be broken down or its reliability remarkably deteriorated.

During repair, carefully take the following precautions. (The following precautions are included in the service parts).

### PRECAUTIONS

#### 1. Ground for the work-desk.

Place a conductive sheet such as a sheet of copper (with impedance lower than  $10^6 \Omega$ ) on the work-desk and place the set on the conductive sheet so that the chassis.

#### 2. Grounding for the test equipment and tools.

Test equipments and toolings should be grounded in order that their ground level is the same the ground of the power source.

#### 3. Grounding for the human body.

Be sure to put on a wrist-strap for grounding whose other end is grounded.

Be particularly careful when the workers wear synthetic fiber clothes, or air is dry.

#### 4. Select a soldering iron that permits no leakage and have the tip of the iron well-grounded.

#### 5. Do not check the laser diode terminals with the probe of a circuit tester or oscilloscope.

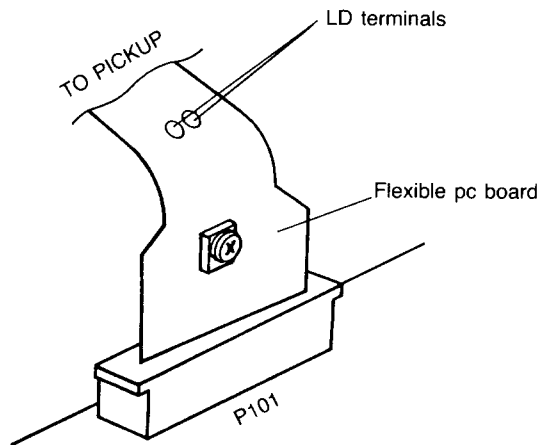

#### (Care should be taken with the optical pickup.)

The optical pickup is sensitive to static electricity, surge currents, and other high electrical noise, and because there is the possibility of damage to performance, in the handling of the pickup, the utmost care must be taken, particularly with regard to static electricity.

1. When replacing the optical pickup, first short the LD terminals and remove the connector. Also, when attaching the new optical pickup, after attaching the connector, unsolder the LD terminals.
2. Do not touch the optical pickup object lens with the hands.

## PROTECTION OF EYES FROM LASER BEAM DURING SERVICING

This set employs a laser. Therefore, be sure to follow carefully the instructions below when servicing.

### WARNING!!

WHEN SERVICING, DO NOT APPROACH THE LASER EXIT WITH THE EYE TOO CLOSELY. IN CASE IT IS NECESSARY TO CONFIRM LASER BEAM EMISSION, BE SURE TO OBSERVE FROM A DISTANCE OF MORE THAN 30cm FROM THE SURFACE OF THE OBJECTIVE LENS ON THE OPTICAL PICK-UP BLOCK.

### Laser Diode Properties

- Material: GaAS/GaAlAs
- Wavelength: 780nm
- Emission Duration: continuous
- Laser output: max. 0.5mW\*

\*This output is the value measured at a distance about 1.8mm from the objective lens surface on the Optical Pick-up Block.

## LASER WARNING LABEL

The label shown below are affixed.

### 1. Certification label (120V model)

This label is located on the back panel.

PRODUCT IS CERTIFIED BY THE MANUFACTURER TO COMPLY WITH DHHS RULES 21 CFR SUBCHAPTER J APPLICABLE AT THE DATE OF MANUFACTURE.

MANUFACTURED

### 2. Class 1 lable (Worldwide model)

This label is located on the back panel.

"CLASS 1 LASER  
PRODUCT"

### 3. Warning lable

This label is located on the chassis of mechanism.

**DANGER** —INVISIBLE LASER RADIATION  
WHEN OPEN AND INTERLOCK FAILED OR  
DEFEATED. AVOID DIRECT EXPOSURE TO BEAM

**CAUTION** —HAZARDOUS LASER AND  
ELECTROMAGNETIC RADIATION WHEN OPEN  
AND INTERLOCK DEFEATED.

**ATTENTION** —RAYONNEMENT LASER  
ET ELECTROMAGNETIQUE DANGEREUX SI  
OUVERT AVEC L'ECLENCHEMENT DE SECURITE  
ANNULE.

### ADVARSEL

"CLASS 1 LASER  
PRODUCT"

Denne mærkning er anbragt på apparatets højre side og indikerer, at apparatet arbejder med laserstråler af klasse 1, hvilket betyder, at der anvendes laserstråler af svageste klasse, og at man ikke på apparatets yderside kan blive udsat for utilladelig kraftig stråling.

APPARATET BØR KUN ÅBNES AF FAGFOLK MED SÆRLIGT KENDSKAB TIL APPARATER MED LASERSTRÅLER!

Indvendigt i apparatet er anbragt den her gengivne advarselmærkning, som advarer imod at foretage sådanne indgreb i apparatet, at man kan komme til at udsætte sig for laserstråling.

ADVARSEL USYNLIG LASERSTRÅLING  
VED ÅBNING, NÅR SIKKERHEDSAF  
BRYDER ER UDE AF FUNKTION  
UNDDÅ UDSÆTTELSE FOR STRÅLING

VAROITUS! Laite sisältää laserdiodin, joka lähettää (näkymätöntä) silmille vaarallista lasersäteilyä.

## PACKING VIEW

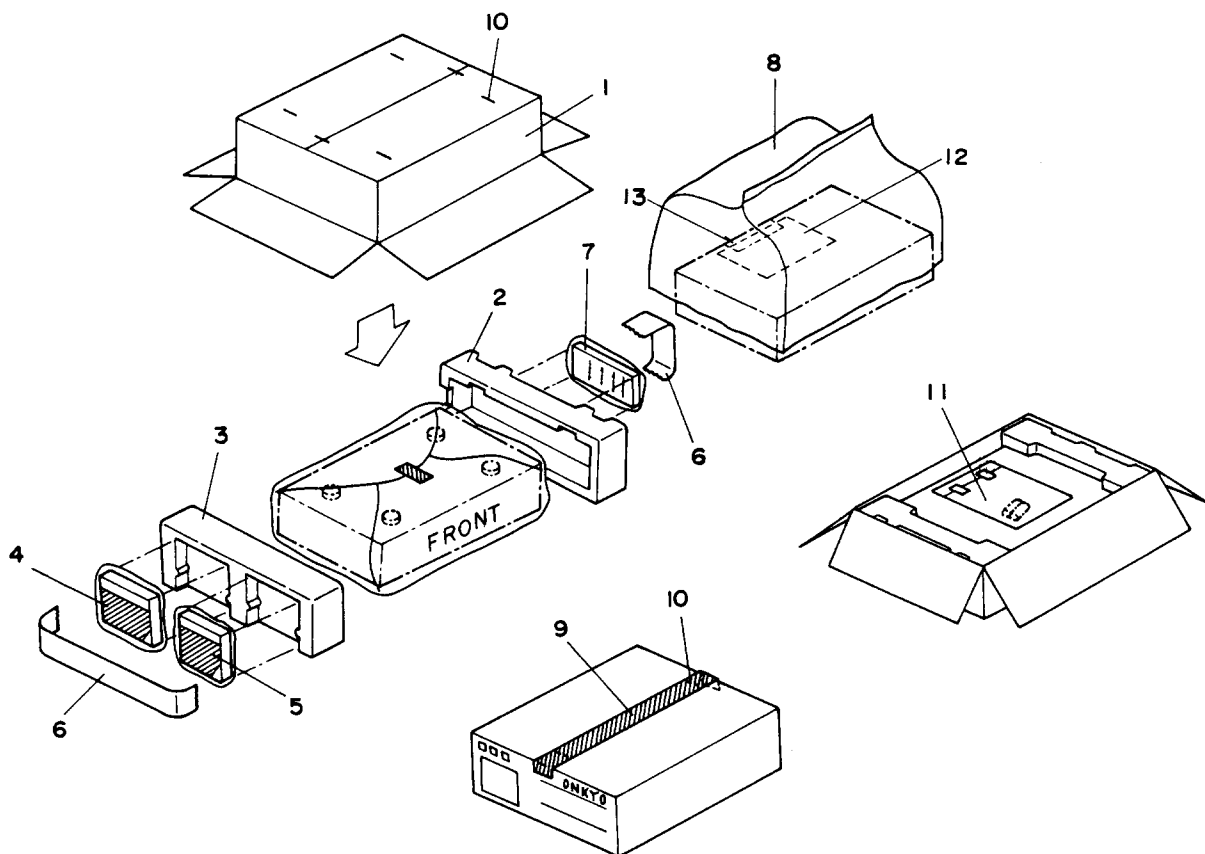

REF.NO.	PART NO.	DESCRIPTION
1	29052093	Master carton box
2	29091344-1A	Pad L
3	29091345-1A	Pad R
4	24506790A	KC-M6, Magazine
5	24506791A	KC-S1, Magazine
6	29110071	Damplon tape
7	24140147	RC-147C, Remote control
8	29100034A	650 × 850, Poly-vinyl bag
9	29110071-1	Damplon tape
10	282301	Sealing hook
11	Accessory bag ass'y	
	2010098A	Connection cable
	2010200	Remote control cable
	3010054	UM-3, Two batteries
	29341543	Instruction manual
	29100097	350 × 250, Poly-vinyl bag
	29365019	Warranty card <Only U.S.A model>
	29358002 J	Service station list <Only U.S.A model>
	25055040	CV-K-2, Conversion plug <Only Worldwide model>
12	29355158	Caution label
13	29110069	Adhesive tape